

# JAN-9201/7201 Specifications

Model	26-inch model	JAN-9201
	19-inch model	JAN-7201
Conforming to IMO standards		✓
<b>Hardware function</b>		
Display unit	JAN-9201: 26-inch WUXGA color LCD, 1920 × 1200 pixels, touch panel (sold separately) JAN-7201: 26-inch WUXGA color LCD, 1280 × 1024 pixels, touch panel (sold separately)	
Central control block	Intel Core i5 2515E 2.5 GHz 2-GB main memory SSD × 2 DVD drive × 1	
Power supply	24 V DC or single-phase 100 to 115V AC or 220 to 240 V AC at 50/60 Hz	
Power consumption	Rating JAN-9201: 240 VA max.; JAN-7201: 200 VA max.	
<b>Chart display function</b>		
Chart database	ENC: S-57 Ed3.0/3.1 and S-63 AVCS (AIO supported), NAVTOR ENC Service, and Jeppesen ENC Service Raster charts: ARCS Personal chart: Jeppesen Ed.3 Professional/Professional+	
Operation mode	TM (true motion)/RM (relative motion) display	
Azimuth display mode	True motion mode: North UP/Course UP/Head UP/Waypoint UP Relative motion mode: North UP/Course UP/Head UP/Waypoint UP	
Scale	1:1,000 to 1:20,000,000 (WUXGA)/1:40,000,000 (SXGA)/1:20,000,000 (FHD)	
Range	0.125, 0.25, 0.5, 0.75, 1.5, 3, 6, 12, 24, 48, 96NM	
Multi-window display	Upper-lower split/Left-right split/Picture-in-picture	
<b>Route planning function</b>		
Route creation	Table/Graphic editing	
Route editing	Waypoint addition/deletion/edition Alternative route creation Route copy Connection between routes Import/export (in CSV)	
Safety check	Yes	
Number of routes displayed	Four types max.	
<b>Navigation-monitoring function</b>		
Own ship	Monitoring for position, wake, and dragging anchor	
Route monitoring	Water depths, obstacles, approaching prohibited areas, course deviation, waypoints, and arrival time	
Other ship monitoring	TT display 200 targets max. (100 targets per radar and responding to a maximum of two radars) AIS display: 500 targets max. (expanding to a maximum 1,000 targets with an optional function added)	
<b>User map</b>		
Number of display points	100,000 points (marks and lines)	
Import/Export	Possible with USB memory	
<b>Other functions</b>		
Data display function	Conning data block display	
Self-diagnostic function	Standard	
Remote maintenance function	Standard	
Playback	Navigation data (3 months max.) Logbook (3 months max.)	
Radar overlay	Optional (software license)	
TCS	Optional	
S-Joy control supported	Optional	

• Specifications may be subject to change without notice.

For further information, contact:

**JRC** Japan Radio Co., Ltd.  
Since 1915  
URL <http://www.jrc.co.jp/eng/>

**Main Office:** NAKANO CENTRAL PARK EAST  
10-1, Nakano 4-chome, Nakano-ku, Tokyo  
164-8570, Japan  
Telephone: +81-3-6832-1816  
Facsimile: +81-3-6832-1845

**Overseas Branches :** Seattle, Amsterdam, Athens, Manila  
**Liaison Offices :** Taipei, Jakarta, Hanoi, New York  
**Overseas Subsidiaries :** Shanghai, Rio de Janeiro

32EM

ISO9001, ISO14001 Certified

© 2016.5 2017.1 CAT.No.Y14-223 (No.870-1-2) D Printed in Japan

# JAN-9201/7201 ECDIS

**JRC**



\* The photograph includes options.

- Provide a smooth operating environment ensured by high-speed chart drawing.

- Conforming to the latest IMO performance standards with Marine Equipment Directive (MED) certification.
- Ensuring intuitive and easy-to-use display and operation performance reflecting professional user's voices.
- Integrating route editing and route safety checking to support safer route plans.
- Delivered with a software license allowing an expansion tailored to each operational requirement for a wide variety of optional features.
- Providing the J-Marine Cloud service that collectively supports the updating of charts.
- ECDIS type-specific training (TST) is provided by a variety of organizations around the world on behalf of JRC.

**JRC** Japan Radio Co., Ltd.

# JAN-9201/7201

## Mandatory installation and standards

### ECDIS

The Electronic Chart Display and Information System (ECDIS) is a geographic information system for voyage planning and route monitoring to support the safety navigation of ships at sea.

The ECDIS onboard a ship uses images obtained from the automatic identification system (AIS), radar system, and collision avoidance target tracking (TT) system and superposes the images with navigational chart information, thus accurately displaying dynamic information on other ships around. Also the ECDIS plays central roles in the safe navigation of the ship and provides safety functions, including the generation of warnings when the ship approaches dangerous areas. The ECDIS is useful for marine accident avoidance and serves as equipment indispensable to the safe navigation of ships.

### Mandatory installation of ECDIS

In response to the latest revision of the International Convention for the Safety of Life at Sea (SOLAS), the International Maritime Organization (IMO) enforced the mandatory installation of the ECDIS on oceangoing passenger ships with 500 gross tons or more and tankers and cargo ships with 3,000 gross tons or more in a stepwise manner in and after July 2012. This mandatory decision requires conventional paper charts or an additional ECDIS as a backup to the primary ECDIS if a ship uses the primary ECDIS as main navigational equipment. (Requirements for the equipment and operation qualification are subject to approval from the country with which the ship is registered and recommendations from the classification society of the ship.)

Type	Size	Newbuild	Existing
Passenger ship	> 500	July 2012	July 2014
Tanker	> 3,000	July 2012	July 2015
Cargo ship	> 3,000	July 2014	—
	> 10,000	July 2013	July 2018
	> 20,000	July 2013	July 2017
	> 50,000	July 2013	July 2016

### Regulations and major specifications

This equipment conforms to the requirements set out in the IMO's resolution MSC.191 (79) for display-related voyage information adopted in December 2004 and the IMO Resolution MSC.232 (82) for ECDIS performance standards adopted in December 2006. Other specifications of the ECDIS are shown below.

- Electronic chart display function/Radar overlay function : IEC 61174
- Display-related voyage information : IEC 62288
- Track control system (TCS) function \*1 : IEC 62065

\*1. Contact your JRC representative for supporting autopilot models.

# JAN-9201/7201

## Features



### Sophisticated user interface

The JAN-9201/7201 incorporates a new user interface (named jGUI) for an intuitive, easy-to-use, simple menu system based on the display of icons. This interface always displays critical data in fixed positions on the screen while icon-based menu display informs users of corresponding functions straightaway. Furthermore, target tracking (TT) and AIS symbols feature pop-up displays while mouseover on the target showing their main data at a glance.

### Easy-to-use operating unit

The newly designed trackball supports all the operation of the equipment. Users will be alerted with alarms from the operating unit and color changes under situations that require attention.



### Optional keyboard

The ECDIS will be operable like conventional models by connecting an optional operating unit that incorporates dedicated function buttons, control knobs and a full keyboard adopting the QWERTY layout.



### Route editing and safety checking

JRC's new ECDIS model JAN 9201/7201 has integrated route editing, which was conventionally divided into two segments, i.e., graphics input and numeric table input areas, into one. Waypoints, if specified, on a navigational chart are immediately quantified and added to the numeric editing table, and the numeric data on the waypoints that is input into the editing table is immediately reflected on the navigational chart. Up to four routes can be edited at the same time, and a portion cut out of any route can be combined and the routes can be all or partly replaced or edited.

Furthermore, a safety check on edited route data is possible with a click of a button. Detected error information items, if any, are listed and displayed, and the corresponding route portions are highlighted in the chart and table, which can be confirmed at a glance to take remedial measures.

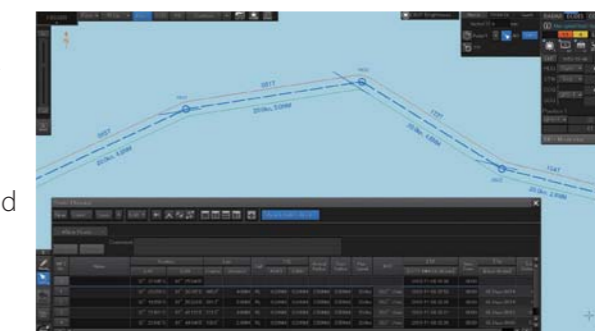

Route editing screen example

# JAN-9201/7201 Display

## Selectable screen sizes

A newly designed narrow-frame 26-inch (WUXGA) and 19-inch (SXGA) LCD monitors are prepared for the JAN-9201/7201. Each monitor adopts an LED backlight, thus providing high-quality images that are highly visible both during the day and at night. Also a touch panel monitor will be available as an option in each size shortly, allowing yet another straightforward way of operating the ECDIS.

Furthermore, an unprecedentedly large 46-inch (FHD) monitor is available optionally. This monitor is almost as large as conventional paper charts and convenient for an offshore ship, for example, if the display needs to be installed away from the maneuvering position. (For details, contact your JRC representative.)

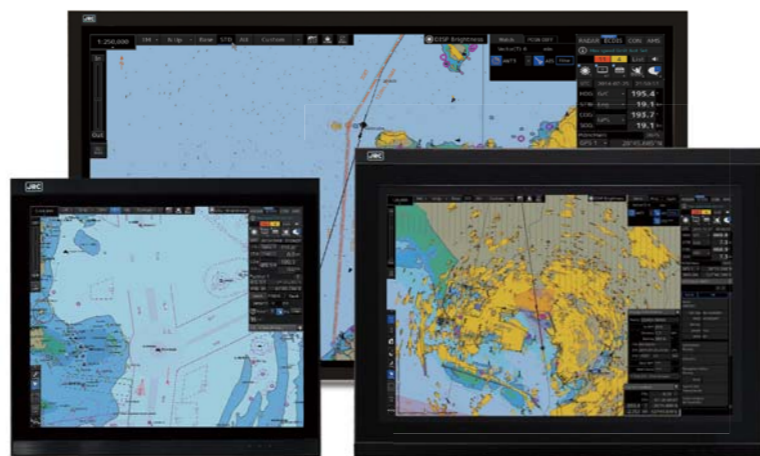

## Correspond to the major chart

The JAN-9201/7201 supports the display of major electronic navigational charts (ENCs), including those provided by ADMIRALTY Vector Chart Service (AVCS) (S-57 Ed 3.0/3.1 and S-63), NAVTOR ENC Service, and Jeppesen ENC Service as well as ADMIRALTY Raster Chart Service (ARCS). Also, it supports advanced features provided with ENCs, such as the Admiralty Information Overlay (AIO) of AVCS by the United Kingdom Hydrographic Office (UKHO) and Dynamic Licensing of Jeppesen ENC service.

JRC provides a one-stop service for ECDIS through its total solution service "J-Marine Cloud". JRC not only acts as a sales agent for chart data but also undertakes all ECDIS-related complicated procedures, including pay-as-you-sail (PAYS) services for the automatic purchasing of updated data on navigational routes. In addition, JRC provides J-Marine Routing that suggests optimum routes based on route planning and the latest weather forecast in combination. For details, visit <http://www.jmarinecloud.com/>.

- ENC (S-57 and S-63 vector charts)
  - AVCS (AIO supported)
  - NAVTOR ENC Service (PAYS supported)
  - Jeppesen ENC Service (Dynamic Licensing supported)
- Raster charts
  - ARCS
- Others (private charts)
  - Jeppesen Ed.3 Professional
  - Jeppesen Ed.3 Professional+

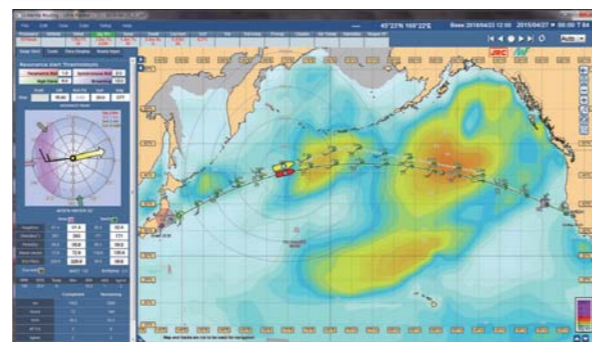

Display example of optimum route by J-Marine Routing

# JAN-9201/7201 Functional expansion and configuration

## Functional expansion

The equipment incorporates a variety of optional functions that will be available with software licenses added. Software licenses can be added before or after the ECDIS comes into operation. Therefore, the ECDIS can be customized to match the actual operating conditions.

### Optional functions

- Expansion of AIS display targets (500 → 1000)
- Radar overlay function\*<sup>1</sup>
- TCS support\*<sup>2</sup>
- S-Joy control support\*<sup>3</sup>
- Satellite communications blocking alarm (Function expanded in the future)

- \*1. The radar overlay function requires an optional radar interface circuit and radar image signal input.
- \*2. The track control system (TCS) function requires auto pilot connections in addition. For details, including corresponding models, contact your JRC representative.
- \*3. For autopilot models connectable to the S-Joy control panel, contact your JRC representative.



Example of additional display of radar overlay function

## Sensor data sharing

The central control unit is provided with the only minimum required external interfaces specified by Marine Equipment Directives (MEDs), and other sensor data is received through the bridge network (LAN) from the interface circuits. The interface circuits are designed to be shared by a number of new-type navigation devices, and each type of interface circuit can be combined and selected according to each signal format and the number of connections.

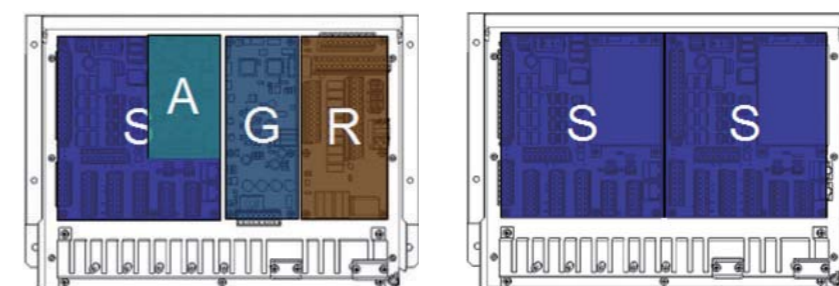

Interface circuit arrangement in NQE-1143 junction box

### Interface circuits

- S : SLC (Serial LAN interface circuit): IEC 61162-2 × 2; IEC 61162-1 × 8; Contact input point × 4; Contact output point × 8
- A : AOC (Analog option circuit)\*<sup>1</sup>: -10 to 10V DC or 4 to 20 mA × 4
- G : GIF (Gyro interface circuit): Gyro signals (Sync and Step); Ship speed pulse signals (100 to 800 pp)
- R : RIF (Radar interface circuit): Interswitch connection × 1; Slave video input × 1

\*1. The installation of the AOC requires a serial LAN interface circuit (SLC).

# JAN-9201/7201

## Technical training

### Type-specific training (TST)

Unlike JRC's conventional ECDIS models, this ECDIS has adopted a new operation system and a TST program supporting the new operation system is required. The TST for the new ECDIS is given at JRC's major branches, agents, and training institutions around the world. The training will be given onboard or offices by instructors dispatched at the request of customers. Furthermore, PC software is available for users' self-learning at home or onboard. For more information about TST, contact your JRC representative.

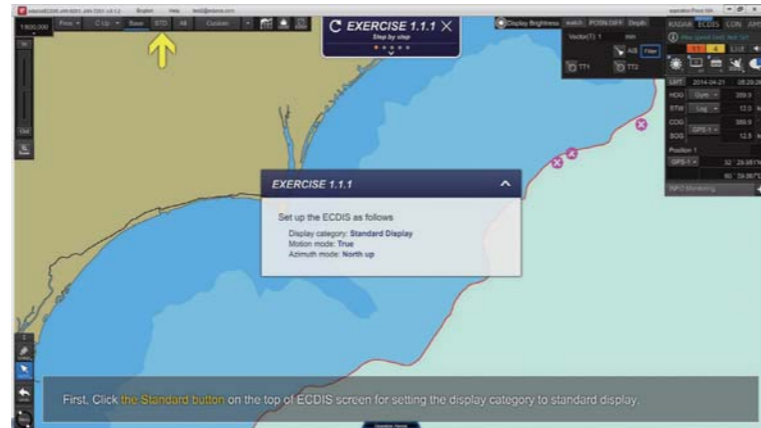

# JAN-9201/7201

## Dimensions and weight

### 19-inch monitor and desktop frame\*

**NWZ-207** Weight: 6 kg    **CWB-1594** Weight: 3.6 kg

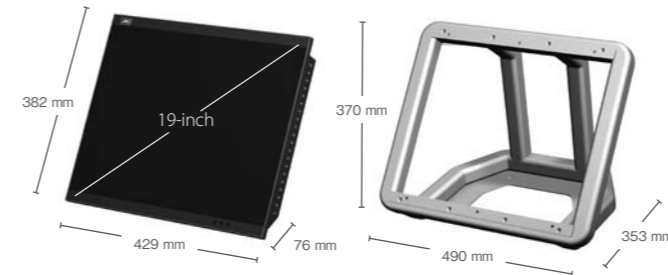

### 26-inch monitor and desktop frame\*

**NWZ-208** Weight: 16 kg    **CWB-1595** Weight: 5.5 kg

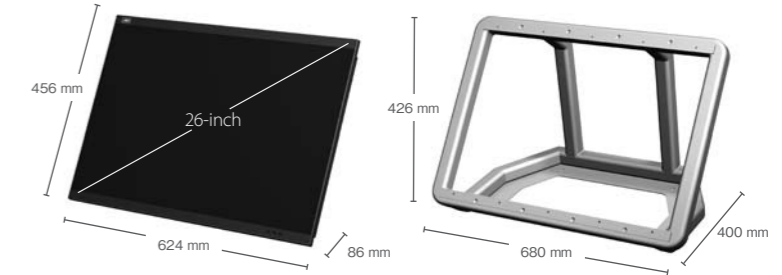

\* Desktop frame is option.

### Central control unit

**NDC-1590** Weight: 5.6 kg



### Power supply unit

**NBD-913** Weight: 4.2 kg



### Block diagram

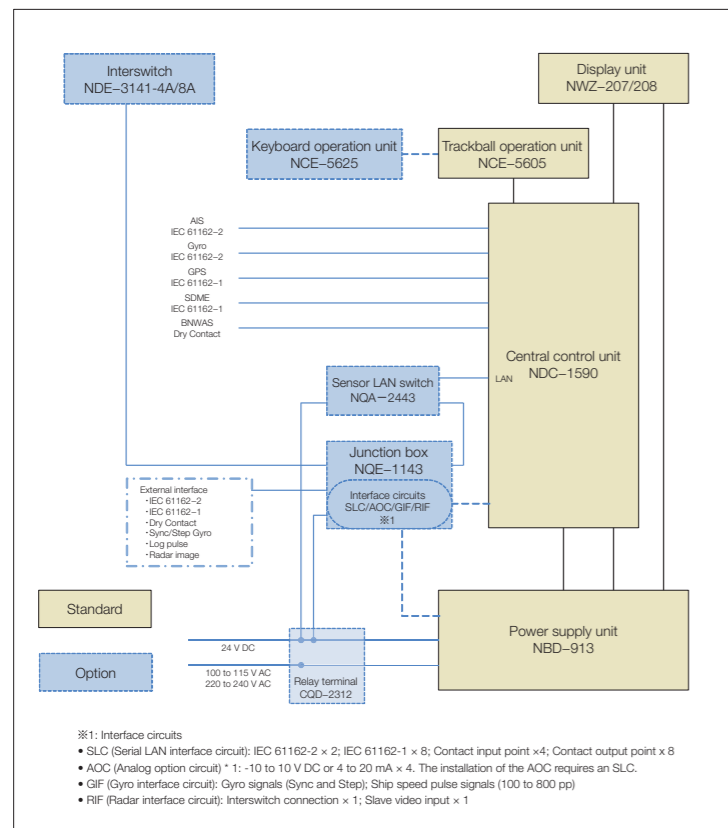

### In the box

- Central control unit
- Power supply unit
- Display unit
- Trackball operation unit

### Options

- Keyboard operation unit
- Sensor LAN switch
- Junction box
- Serial LAN interface circuit
- Analog option circuit
- Gyro interface circuit
- Radar interface circuit
- Relay terminal block
- Display unit mount kit
- Interswitch (4 ch/8 ch)

### Trackball operation unit

**NBD-5605** Weight: 1.3 kg



### Keyboard operation unit (option)

**NBD-5625** Weight: 0.8 kg



### Junction box (option)

**NQE-1143** Weight: 3.8 kg

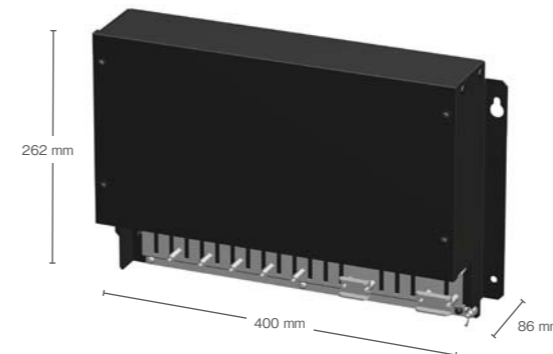

### 19" display unit mount kit / 26" display unit mount kit\*

**CWA-245** Weight: 55 kg    **CWB-246** Weight: 65 kg

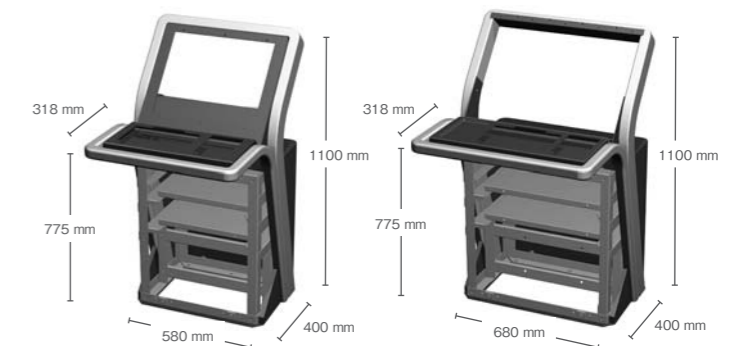

\*Display mount kit is option.